

SFP Single Fiber 2 km transceiver | Cisco Compatible 1G BX Ethernet
Designed for OEM networks such as Cisco, HP, Juniper, Brocade, Alcatel etc.

Datasheet

SFP Optical Transceiver Product Features

- Exclusive Japanese OSAs for Ultimate Reliability
- 1000BASE-LX/LH Ethernet 8dB SFP
- 2 km BX SFP for SMF @ 1.25Gbps
- 1310Tx-1550Rx FP+PIN Laser 2 km SFP
- 0°C - 70°C Temperature - Extended/Industrial Available
- 2-Wire Interface Digital Diagnostic Monitoring (SFF-8724)
- Hot-swappable for SFP LC ports
- Extended 2 Years Warranty
- Tested and Certified in Brand Specific Networks and Target Applications
- Assembled Using Highest Quality Raw Components
- SFP MSA / IEEE Std 802.3 & ROHS

PSFP-11DB31K002



Applications

- 1.25Gbps Gigabit Ethernet
- Fibre Channel 1x
- Optical Fast Ethernet
- Other Optical Links

Description

Platinum OEM Series PSFP-11DB31K002 is a Cisco Compatible Single Fiber BiDirectional 1000BASE-LX/LH Ethernet SFP transceiver designed for long distance optical communications up to 2 km with signaling rates up to 1.25Gbps.

OptoSpan Platinum OEM Series 1.25Gbps Single Fiber BiDirectional (BiDi) optical transceivers have undergone rigorous qualification and certification testing to provide End-to-End Compatibility using switching equipment from CISCO, BROCADE, JUNIPER, ALCATEL, HP (select models), NORTEL, EMC, QLOGIC and other OEMs.

All OptoSpan Platinum OEM Series long-reach SFP s are ROHS compliant, allow for real-time diagnostic monitoring as per SFF-8472 and designed to meet Multi-Source Agreement (MSA) standards for Single Fiber BiDirectional (BiDi) transceivers with LC interface.

Optical Budget Calculation for 2 km Platinum OEM SFP Optical Transceiver

PSFP-11DB31K002	Distance: 2 km				Fiber: 1310Tx-1550Rx	
	Tx Min dBm	Tx Max dBm	Rx Min dBm	Rx Max dBm	Link Attenuation dB	Power Budget dB
Product Specifications	-14	-10	-22	-3		
Optical Calculation Results			-11.9	-5.9	1.9	8

SFP Single Fiber 2 km transceiver | Cisco Compatible 1G BX Ethernet

General Specifications

Parameter	Unit	Min.	Typ.	Max
Absolute Maximum Ratings				
Maximum Supply Voltage	V	-0.5		3.6
Storage Temperature	°C	-40		+85
Case Operating Temperature	°C	0		+70
Recommended Operating Condition				
Supply Voltage	V	3.15	3.3	3.45
Supply Current	mA			300
Data Rate	Gbps		1.25	

Electrical Characteristics

Parameter	Unit	Min.	Typ.	Max
Transmitter				
Differential Input Voltage Swing	mVpp	400		2000
Input Differential Impedance	ohm	85	100	115
Transmit Disable Voltage - High	V	2		Vcc+0.3
Transmit Disable Voltage - Low	V	0		0.8
Transmit Fault Voltage - High	V	2		Vcc+0.3
Transmit Fault Voltage - Low	V	0		0.5
Receiver				
Differential Output Voltage Swing	mVpp	400		2000
Differential Output Impedance	ohms	85	100	115
LOS Output Voltage - High	V	2		Vcc+0.3
LOS Output Voltage - Low	V	0		0.8

SFP Single Fiber 2 km transceiver | Cisco Compatible 1G BX Ethernet

Optical Characteristics

Parameter	Unit	Min.	Typ.	Max
Transmitter				
Output Optical Power	dBm	-14		-10
Optical Extinction Ratio	dB	9		
Optical Wavelength	nm	1260	1310	1360
Spectral Width	nm			4
Side Mode Suppression Ratio	dB			
Receiver				
Optical Center Wavelength	nm	1500	1550	1580
Receiver Sensitivity @	dBm	-22		-3
LOS DE-Assert	dBm			-25
LOS Assert	dBm	-42		

Laser Safety

This is a class 1 Laser Product according to IEC 60825-1:1993:+A1:1997+A2:2001. This product complies with 21 CFR 1040.10 and 1040 except for deviations pursuant to Laser Notice No. 50, dated July 26, 2001.

SFP Single Fiber 2 km transceiver | Cisco Compatible 1G BX Ethernet

PIN Layout

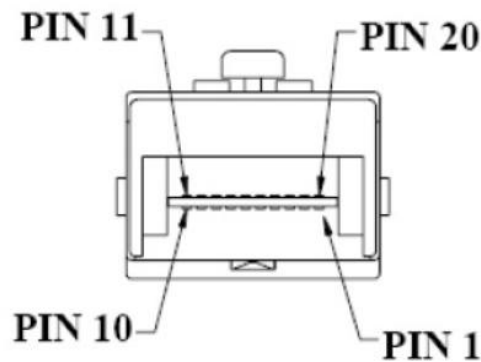
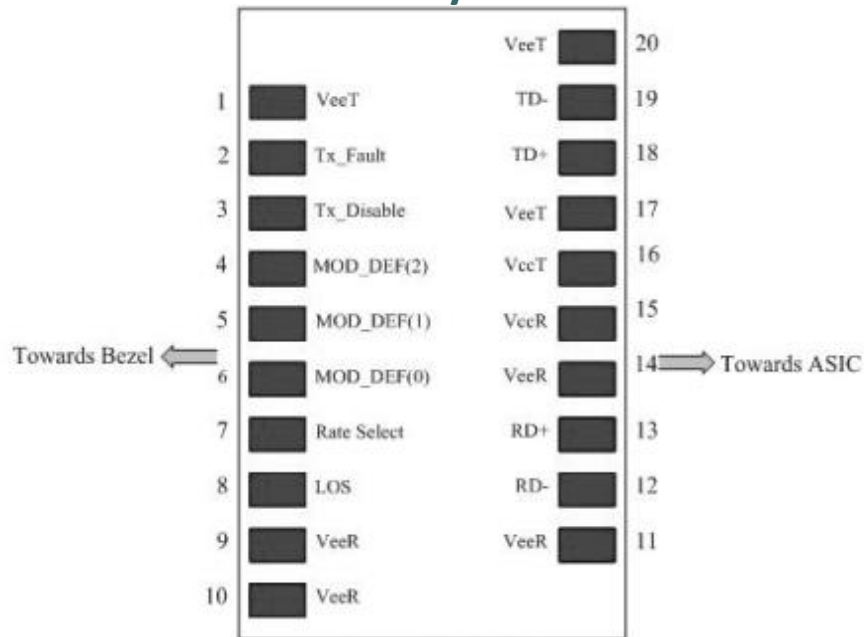

SFP Single Fiber 2 km transceiver | Cisco Compatible 1G BX Ethernet

PIN Functions

Pin #	Name - Description
1	Transmitter Ground
2	Transmitter Fault Indication
3	Transmitter Disable
4	Module Definition 2
5	Module Definition 1
6	Module Definition 0
7	Not Connected
8	Loss of Signal
9	Receiver Ground
10	Receiver Ground
11	Receiver Ground
12	Inv. Received Data Out
13	Received Data Out
14	Receiver Ground
15	Receiver Power
16	Transmitter Power
17	Transmitter Ground
18	Transmit Data In
19	Inv. Transmit Data In
20	Transmitter Ground
21	
22	
23	
24	
25	
26	
27	
28	
29	
30	

SFP Single Fiber 2 km transceiver | Cisco Compatible 1G BX Ethernet Mechanical Layouts

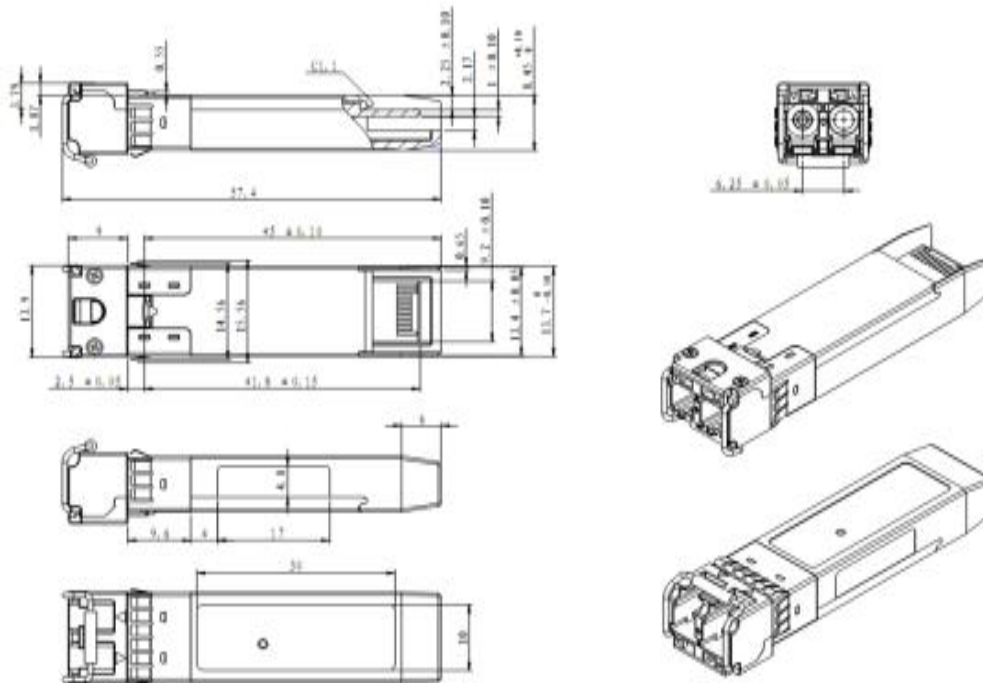
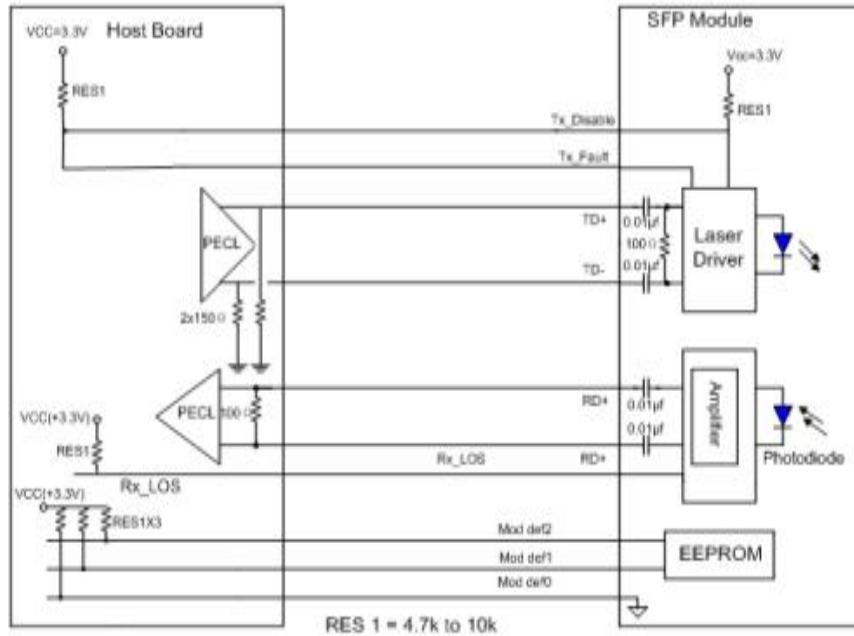

OptoSpan reserves the right to make changes or to discontinue any optical product or service without any notice. Applications and features described herein are for illustrative purposes only. OptoSpan makes no representation of warranty that such applications or features will be suitable for any specific use or compatibility without further testing or modifications. Not responsible for typographical errors.